

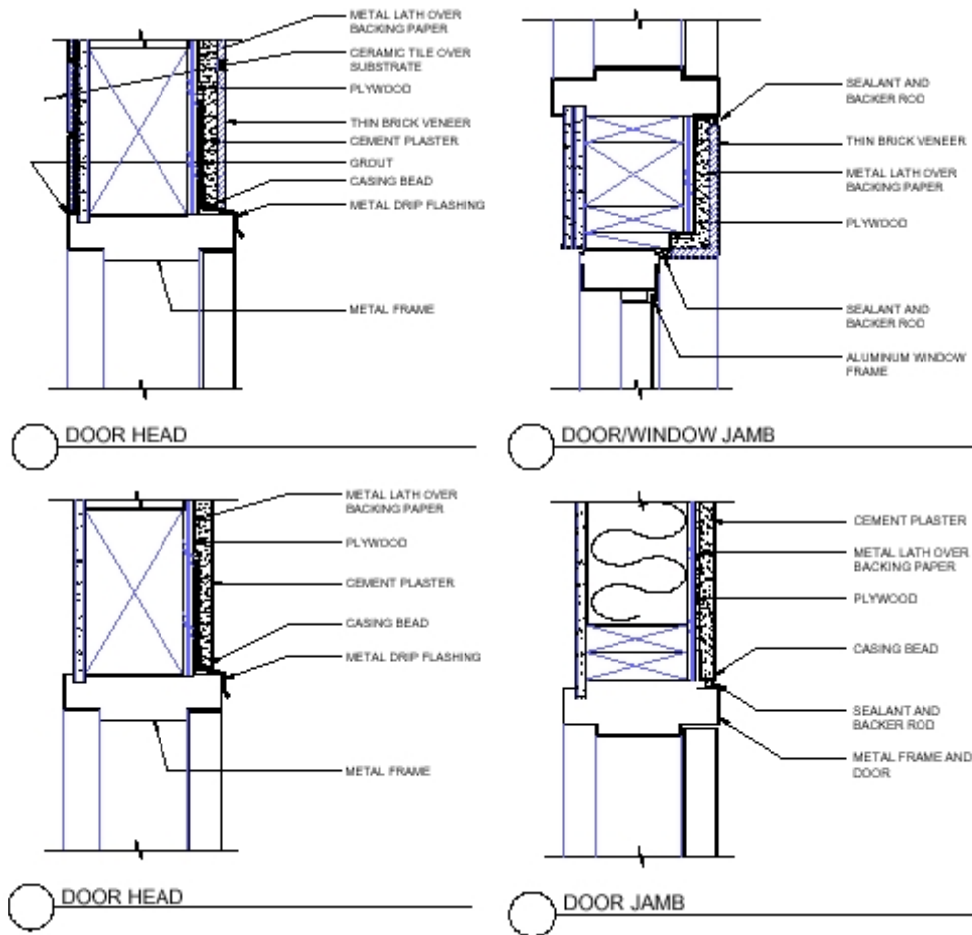

TECHNICAL BULLETIN

Standard Details

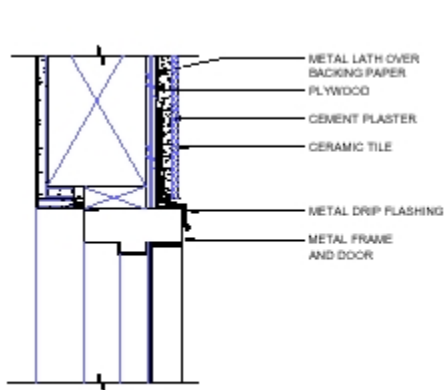



DOOR HEAD

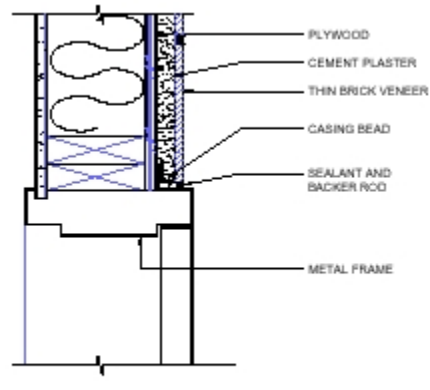

DOOR JAMB

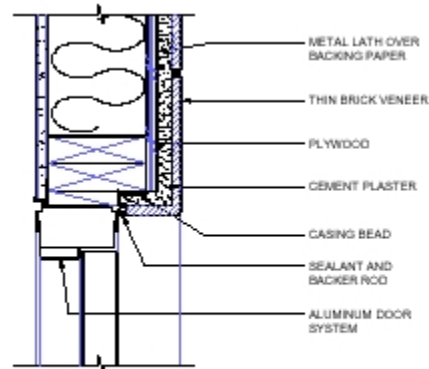

DOOR JAMB

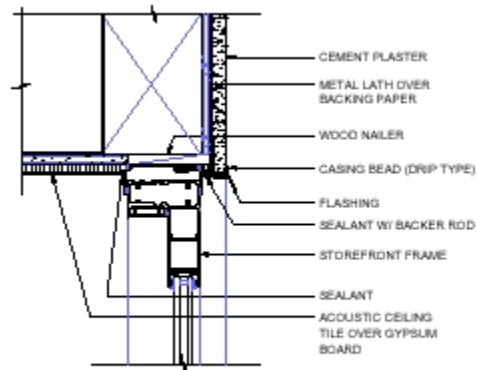

STOREFRONT HEAD

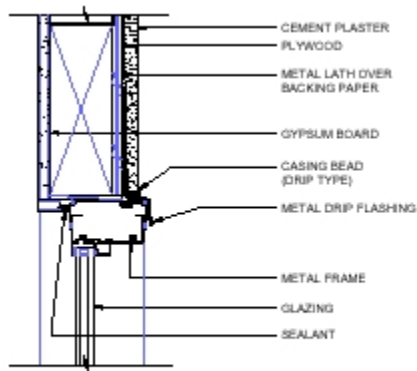

WINDOW HEAD

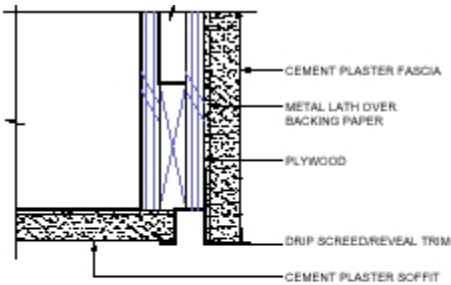

PLASTER FASCIA/PLASTER SOFFIT

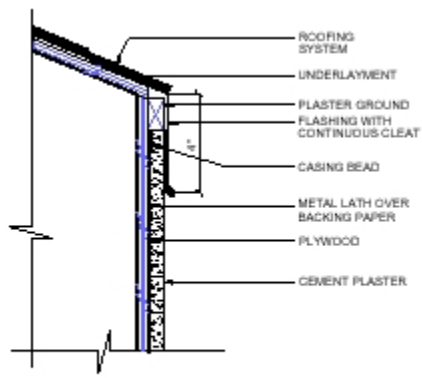

FASCIA

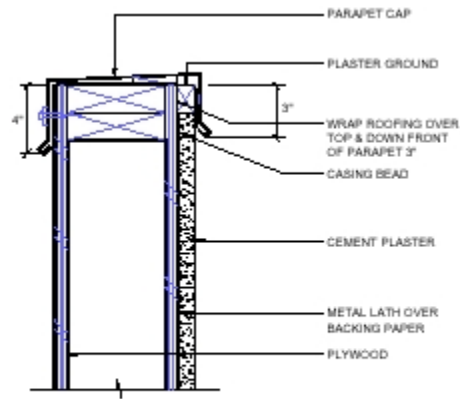

PARAPET CAP @ PLASTER FASCIA

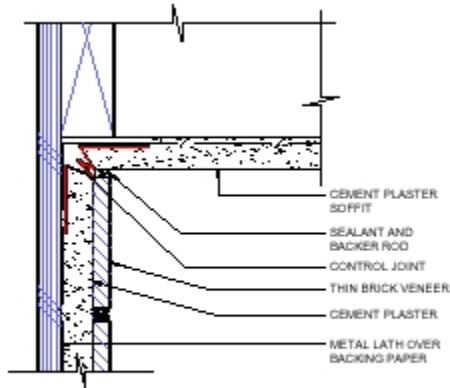

SOFFIT @ WALL-INSIDE CORNER

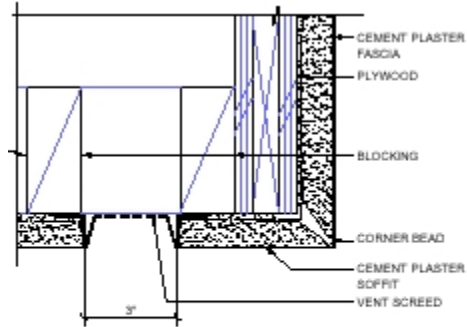

PLASTER FASCIA/SOFFIT VENT

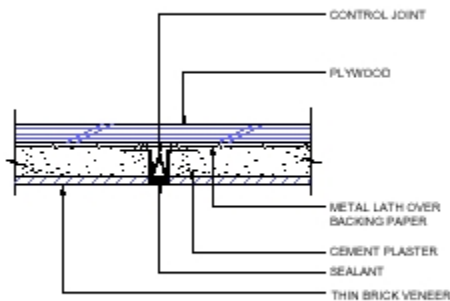

CONTROL JOINT @ THIN BRICK VENEER

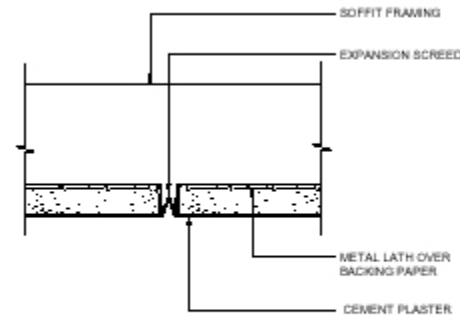

EXPANSION JOINT @ SOFFIT

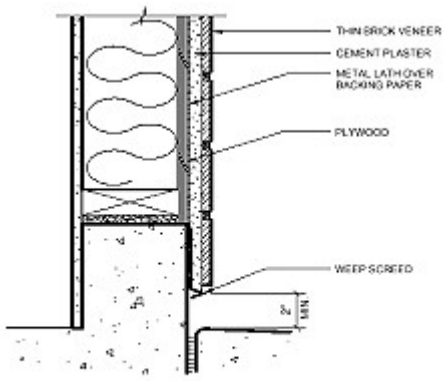

○ FOUNDATION WEEP SCREED

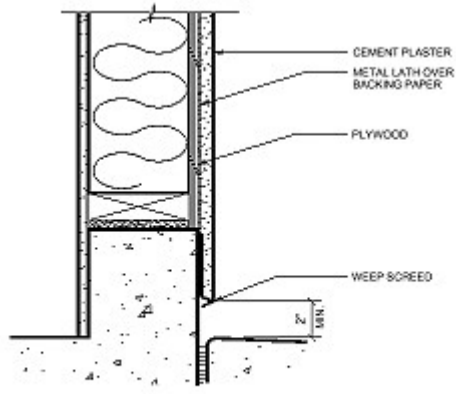

○ FOUNDATION WEEP SCREED